



**THE DATASHEET OF  
PACDN1408CG**



# PACDN1404

## ESD Protection Diode Arrays Chip Scale Package

### Product Description

The PACDN1404 and PACDN1408 are 4- and 8-channel surge protection arrays that provide a very high level of protection for sensitive electronic components that may be subjected to ESD.

These devices are designed and characterized to safely dissipate ESD strikes at levels well beyond the maximum requirements set forth in the IEC 61000-4-2 international standard (Level 4,  $\pm 8$  kV contact discharge). All I/Os are rated at  $\pm 25$  kV using the IEC 61000-4-2 contact discharge method. Using the MIL-STD-883D (Method 3015) specification for Human Body Model (HBM) ESD, all pins are protected for contact discharges to greater than  $\pm 30$  kV.

The Chip Scale Package format of these devices provide extremely small footprints that are necessary in portable electronics such as cellular phones, PDAs, internet appliances and PCs. The large solder bumps allow for standard attachments to laminate boards without the use of underfill. The PACDN1404 and PACDN1408 are packaged in RoHS-compliant, lead-free finishing.

### Features

- Four or Eight surge protection in a Single Package
- In-System Electrostatic Discharge (ESD) Protection to  $\pm 25$  kV Contact Discharge per IEC 61000-4-2 International Standard
- Compact Chip Scale Package (CSP) in a 0.65 mm Pitch Format Saves Board Space and Eases Layout in Space Critical Applications Compared to Discrete Solutions and Traditional Wire Bonded Packages
- 6- and 10-Bump WLCSPs
- These Devices are Pb-Free and are RoHS Compliant

### Applications

- ESD Protection for Sensitive Electronic Equipment
- I/O Port, Keypad and Button Circuitry Protection for Portable Devices
- Wireless Handsets
- Handheld PCs / PDAs
- MP3 Players
- Digital Cameras and Camcorders
- Notebooks
- Desktop PCs



ON Semiconductor®

[www.onsemi.com](http://www.onsemi.com)



WLCSP6  
CG SUFFIX  
CASE 567BD



WLCSP10  
CG SUFFIX  
CASE 567BM

### ELECTRICAL SCHEMATIC

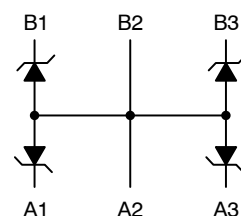

PACDN1404

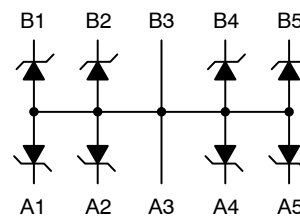

PACDN1408

### MARKING DIAGRAM



D14 = PACDN1404CG  
DN1408 = PACDN1408CG

### ORDERING INFORMATION

Device	Package	Shipping <sup>†</sup>
PACDN1404CG	WLCSP6 (Pb-Free)	3500/Tape & Reel
PACDN1408CG	WLCSP10 (Pb-Free)	3500/Tape & Reel

<sup>†</sup>For information on tape and reel specifications, including part orientation and tape sizes, please refer to our Tape and Reel Packaging Specification Brochure, BRD8011/D.

# PACDN1404

## PACKAGE / PINOUT DIAGRAMS

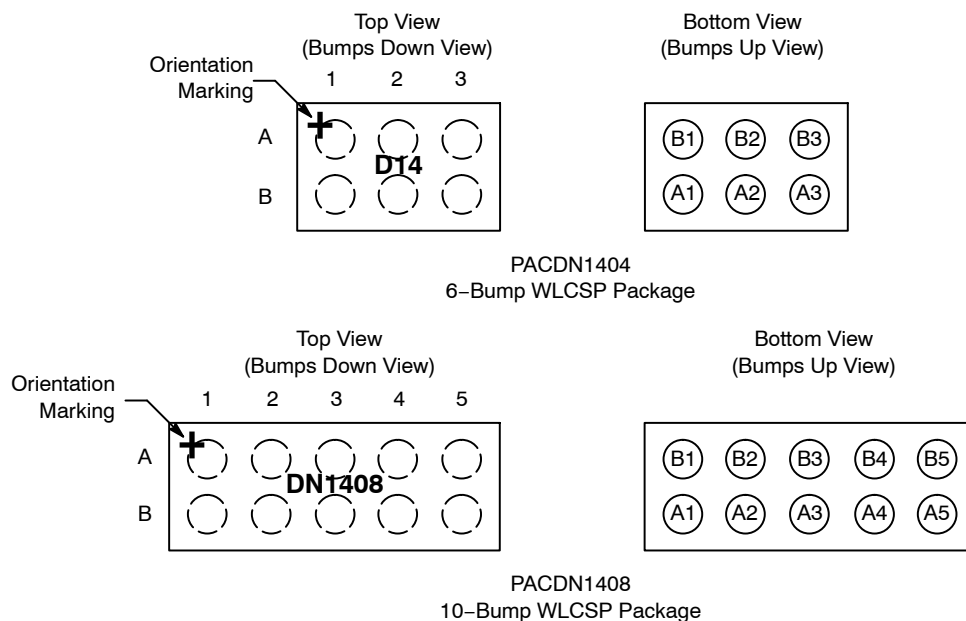

## SPECIFICATIONS

**Table 1. ABSOLUTE MAXIMUM RATINGS**

Parameter	Rating	Units
Storage Temperature Range	-65 to +150	°C

Stresses exceeding those listed in the Maximum Ratings table may damage the device. If any of these limits are exceeded, device functionality should not be assumed, damage may occur and reliability may be affected.

**Table 2. STANDARD OPERATING CONDITIONS**

Parameter	Rating	Units
Operating Temperature Range	-40 to +85	°C

**Table 3. ELECTRICAL OPERATING CHARACTERISTICS** (Note 1)

Symbol	Parameter	Conditions	Min	Typ	Max	Units
$V_{REV}$	Reverse Standoff Voltage	$I_{DIODE} = 10 \mu A$	5.5			V
$I_{LEAK}$	Leakage Current	$V_{IN} = 3.3 V DC$			100	nA
$V_{SIG}$	Signal Clamp Voltage Positive Clamp Negative Clamp	$I_{LOAD} = 10 mA$	5.6 -1.2	6.8 -0.8	8.0 -0.4	V
$V_{ESD}$	In-system ESD Withstand Voltage a) Human Body Model, MIL-STD-883, Method 3015 b) Contact Discharge per IEC 61000-4-2 Level 4	(Note 2)	$\pm 30$ $\pm 25$			kV
$V_{CL}$	Clamping Voltage during ESD Discharge MIL-STD-883 (Method 3015), 8 kV Positive Transients Negative Transients	(Note 2)		+12 -8		V
C	Channel Capacitance	At 2.5 V DC, $f = 1 MHz$		39	47	pF

- $T_A = 25^\circ C$  unless otherwise specified. GND in this document refers to the lower supply voltage.
- ESD applied to channel pins with respect to GND, one at a time. All other channels are open. All GND pins tied to ground.

# PACDN1404

## APPLICATION INFORMATION

Parameter	Value
Pad Size on PCB	0.240 mm
Pad Shape	Round
Pad Definition	Non-Solder Mask Defined Pads
Solder Mask Opening	0.290 mm Round
Solder Stencil Thickness	0.125 mm – 0.150 mm
Solder Stencil Aperture Opening (Laser Cut, 5% Tapered Walls)	0.300 mm Round
Solder Flux Ratio	50/50 by Volume
Solder Paste Type	No Clean
Pad Protective Finish	OSP (Entek Cu Plus 106A)
Tolerance – Edge To Corner Ball	$\pm 50 \mu\text{m}$
Solder Ball Side Coplanarity	$\pm 20 \mu\text{m}$
Maximum Dwell Time Above Liquidous (183°C)	60 seconds
Maximum Soldering Temperature for Lead-free Devices Using a Lead-free Solder Paste	260°C

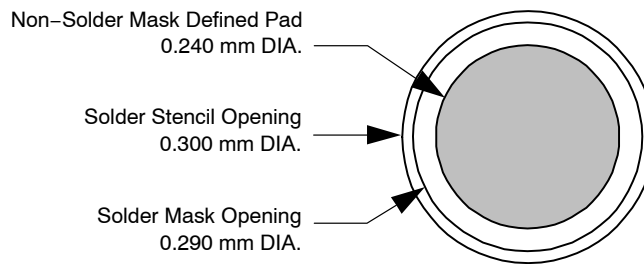

Figure 1. Recommended Non-Solder Mask Defined Pad Illustration

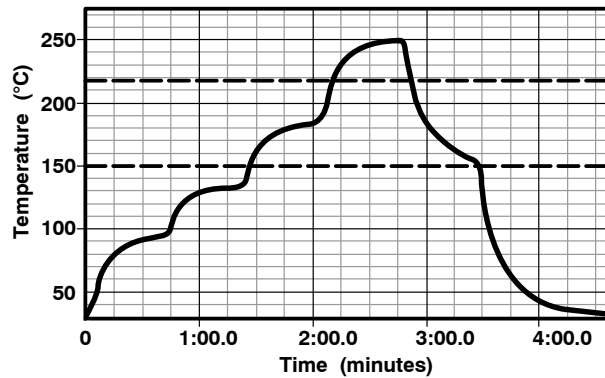
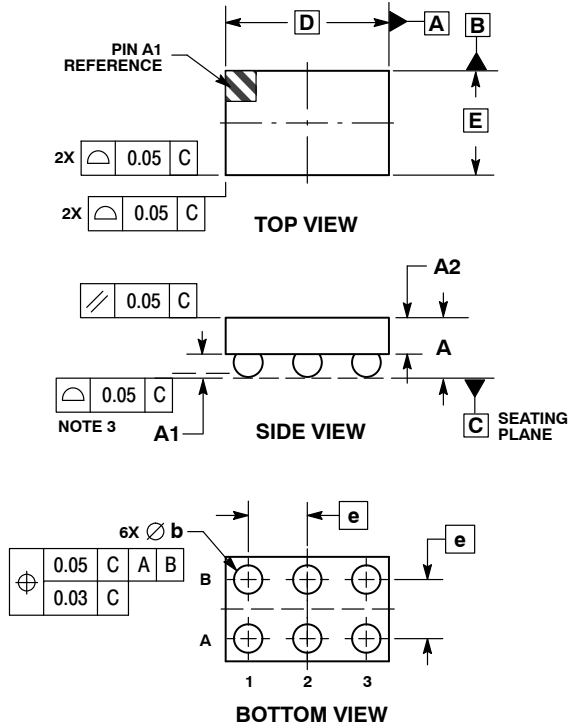

Figure 2. Lead-free (SnAgCu) Solder Ball Reflow Profile

# PACDN1404

## PACKAGE DIMENSIONS

WLCSP6, 1.80x1.15  
CASE 567BD-01  
ISSUE O



### NOTES:

1. DIMENSIONING AND TOLERANCING PER ASME Y14.5M, 1994.
2. CONTROLLING DIMENSION: MILLIMETERS.
3. COPLANARITY APPLIES TO SPHERICAL CROWNS OF SOLDER BALLS.

DIM	MILLIMETERS	
	MIN	MAX
A	0.60	0.69
A1	0.23	0.29
A2	0.38	REF
b	0.34	0.39
D	1.80	BSC
E	1.15	BSC
e	0.65	BSC

### RECOMMENDED SOLDERING FOOTPRINT\*

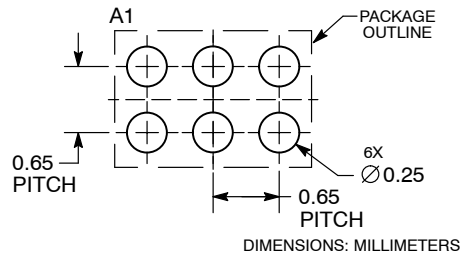

\*For additional information on our Pb-Free strategy and soldering details, please download the ON Semiconductor Soldering and Mounting Techniques Reference Manual, SOLDERRM/D.

# PACDN1404

## PACKAGE DIMENSIONS

WLCSP10, 3.10x1.15  
CASE 567BM-01  
ISSUE O

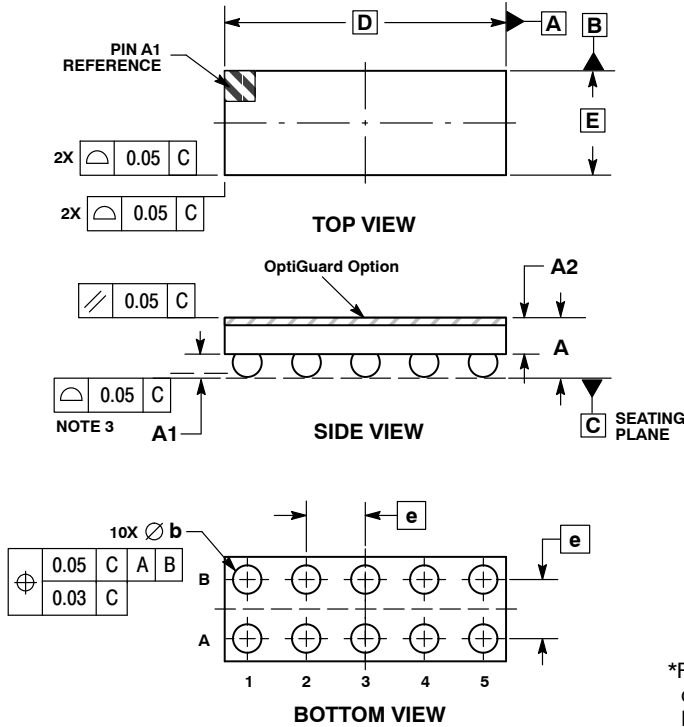

**NOTES:**

1. DIMENSIONING AND TOLERANCING PER ASME Y14.5M, 1994.
2. CONTROLLING DIMENSION: MILLIMETERS.
3. COPLANARITY APPLIES TO SPHERICAL CROWNS OF SOLDER BALLS.

DIM	MILLIMETERS	
	MIN	MAX
A	0.60	0.75
A1	0.23	0.29
A2	0.40 REF	
b	0.34	0.39
D	3.10 BSC	
E	1.15 BSC	
e	0.65 BSC	

### RECOMMENDED SOLDERING FOOTPRINT\*

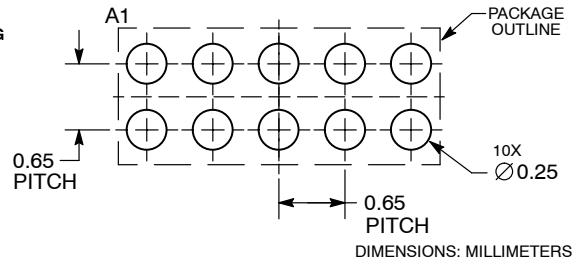

\*For additional information on our Pb-Free strategy and soldering details, please download the ON Semiconductor Soldering and Mounting Techniques Reference Manual, SOLDERRM/D.

ON Semiconductor and are trademarks of Semiconductor Components Industries, LLC dba ON Semiconductor or its subsidiaries in the United States and/or other countries. ON Semiconductor owns the rights to a number of patents, trademarks, copyrights, trade secrets, and other intellectual property. A listing of ON Semiconductor's product/patent coverage may be accessed at [www.onsemi.com/site/pdf/Patent-Marking.pdf](http://www.onsemi.com/site/pdf/Patent-Marking.pdf). ON Semiconductor reserves the right to make changes without further notice to any products herein. ON Semiconductor makes no warranty, representation or guarantee regarding the suitability of its products for any particular purpose, nor does ON Semiconductor assume any liability arising out of the application or use of any product or circuit, and specifically disclaims any and all liability, including without limitation special, consequential or incidental damages. Buyer is responsible for its products and applications using ON Semiconductor products, including compliance with all laws, regulations and safety requirements or standards, regardless of any support or applications information provided by ON Semiconductor. "Typical" parameters which may be provided in ON Semiconductor data sheets and/or specifications can and do vary in different applications and actual performance may vary over time. All operating parameters, including "Typicals" must be validated for each customer application by customer's technical experts. ON Semiconductor does not convey any license under its patent rights nor the rights of others. ON Semiconductor products are not designed, intended, or authorized for use as a critical component in life support systems or any FDA Class 3 medical devices or medical devices with a same or similar classification in a foreign jurisdiction or any devices intended for implantation in the human body. Should Buyer purchase or use ON Semiconductor products for any such unintended or unauthorized application, Buyer shall indemnify and hold ON Semiconductor and its officers, employees, subsidiaries, affiliates, and distributors harmless against all claims, costs, damages, and expenses, and reasonable attorney fees arising out of, directly or indirectly, any claim of personal injury or death associated with such unintended or unauthorized use, even if such claim alleges that ON Semiconductor was negligent regarding the design or manufacture of the part. ON Semiconductor is an Equal Opportunity/Affirmative Action Employer. This literature is subject to all applicable copyright laws and is not for resale in any manner.

### PUBLICATION ORDERING INFORMATION

**LITERATURE FULFILLMENT:**

Literature Distribution Center for ON Semiconductor  
19521 E. 32nd Pkwy, Aurora, Colorado 80011 USA  
Phone: 303-675-2175 or 800-344-3860 Toll Free USA/Canada  
Fax: 303-675-2176 or 800-344-3867 Toll Free USA/Canada  
Email: [orderlit@onsemi.com](mailto:orderlit@onsemi.com)

**N. American Technical Support:** 800-282-9855 Toll Free  
USA/Canada  
**Europe, Middle East and Africa Technical Support:**  
Phone: 421 33 790 2910  
**Japan Customer Focus Center**  
Phone: 81-3-5817-1050

**ON Semiconductor Website:** [www.onsemi.com](http://www.onsemi.com)  
**Order Literature:** <http://www.onsemi.com/orderlit>

For additional information, please contact your local Sales Representative

## Looking for pricing, stock, or lifecycle information?

Click below to explore more details on WIN SOURCE:

 [View PACDN1408CG](#) on WIN SOURCE

 [ON Semiconductor](#) Information

## Optimize Your Supply Chain with WIN SOURCE Solutions

-  Global Sourcing Solution
-  Obsolete Management
-  Cost Control Management
-  Shortage Management
-  Alternative Solution
-  Excess Inventory Management