



THE DATASHEET OF SM2T18A





FEATURES

- High Peak pulse power:
200 W (10/1000 μ s)
1000 W (8/20 μ s)
- Stand-off voltage range 5 to 24V
- Unidirectional types
- Low clamping factor V_{CL}/V_{BR}
- Fast response time
- 1.0mm overall component height

DESCRIPTION

The SM2T series are Transil diodes designed specifically for portable equipment and miniaturized electronics devices subject to ESD transient over-voltages.

Fully compatible with pick and place equipment and inspectable soldering joints.

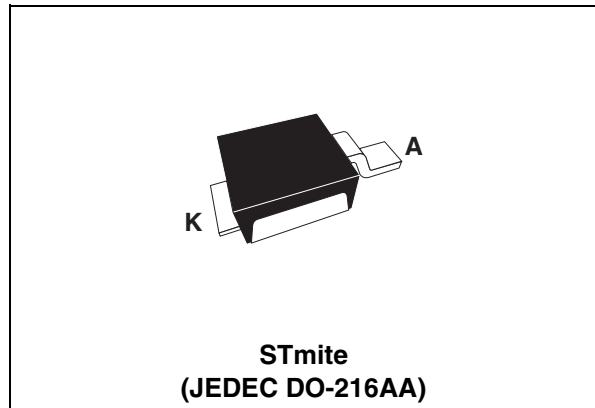

Table 1: Order Codes

Part Number	Marking
SM2T6V8A	MUA
SM2T14A	MUE
SM2T18A	MUG
SM2T27A	MUJ

Table 2: Absolute Ratings ($T_{amb} = 25^{\circ}\text{C}$)

Symbol	Parameter	Value	Unit
P_{PP}	Peak pulse power dissipation (see note 1)	$T_j \text{ initial} = T_{amb}$ 200	W
P	Power dissipation on infinite heatsink	$T_{amb} = 100^{\circ}\text{C}$ 2.5	W
I_{FSM}	Non repetitive surge peak forward current	$t_p = 10 \text{ ms}$ $T_j \text{ initial} = T_{amb}$ 25	A
T_{stg} T_j	Storage temperature range Maximum junction temperature	-65 to 175 150	$^{\circ}\text{C}$
T_L	Maximum lead temperature for soldering during 10 s.	260	$^{\circ}\text{C}$

Note 1: 10/1000 μ s pulse waveform.

Table 3: Thermal Resistances

Symbol	Parameter	Value	Unit
$R_{th(j-t)}$	Junction to tab	20	$^{\circ}\text{C}/\text{W}$
$R_{th(j-a)}$	Junction to ambient on PCB with recommended pad layout	250	$^{\circ}\text{C}/\text{W}$

SM2T

Table 4: Electrical Characteristics ($T_{amb} = 25^{\circ}\text{C}$)

Symbol	Parameter
V_{RM}	Stand-off voltage
V_{BR}	Breakdown voltage
V_{CL}	Clamping voltage
I_{RM}	Leakage current @ V_{RM}
I_{PP}	Peak pulse current
αT	Voltage temperature coefficient
V_F	Forward voltage drop

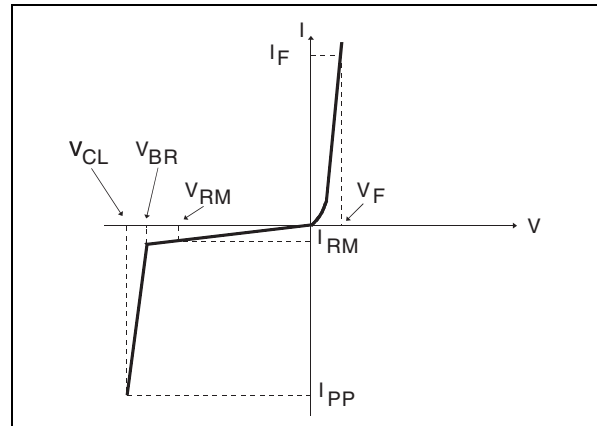

Types	I_{RM} @ V_{RM}		V_{BR} @ I_R		V_{CL} @ I_{PP}		αT	C
	max		min		max note1		max	typ @ 0V
	μA	V	V	mA	V	A	$10^{-4}/^{\circ}\text{C}$	pF
SM2T6V8A	50	5	6.4	10	9.2	19.6	5.7	1600
SM2T14A	1	12	13.3	1	19.9	9	8.3	650
SM2T18A	1	16	17.1	1	26	7	8.8	500
SM2T27A	1	24	25.7	1	28.9	4.6	9.6	350

Note 1: 10/1000 μs pulse waveform.

Figure 1: Peak pulse power versus exponential pulse duration

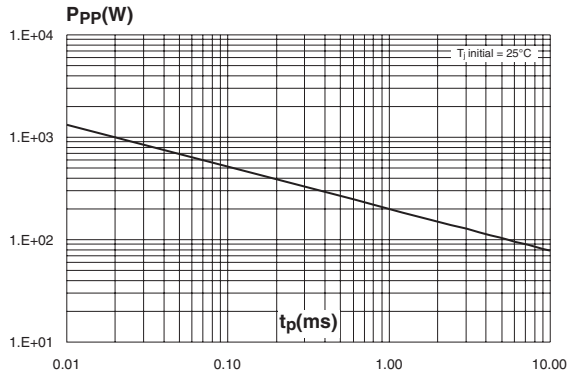

Figure 2: Relative variation of peak pulse power versus initial junction temperature

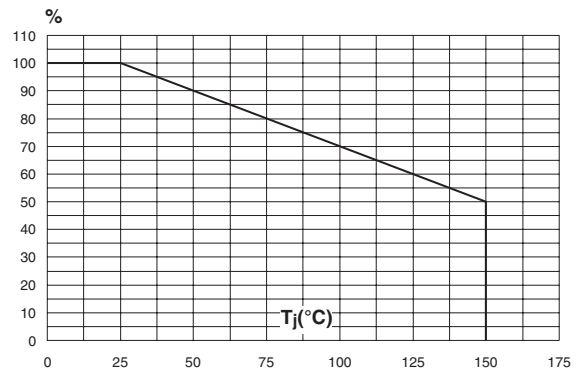

Figure 3: Average power dissipation versus ambient temperature

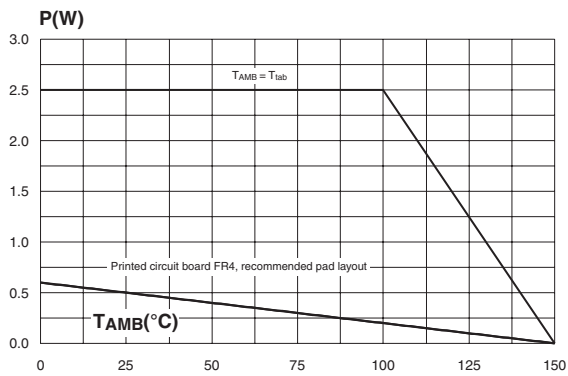

Figure 4: Variation of thermal impedance junction to ambient versus pulse duration

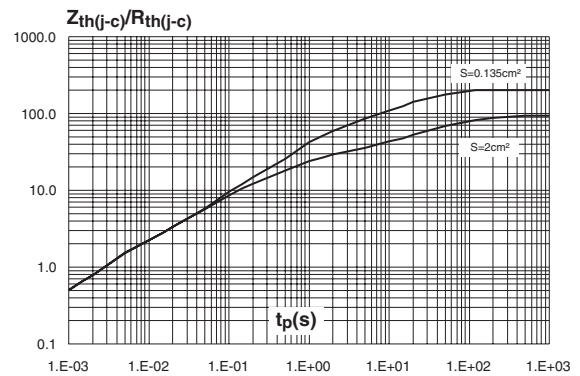

Figure 5: Thermal resistance junction to ambient versus copper surface under tab

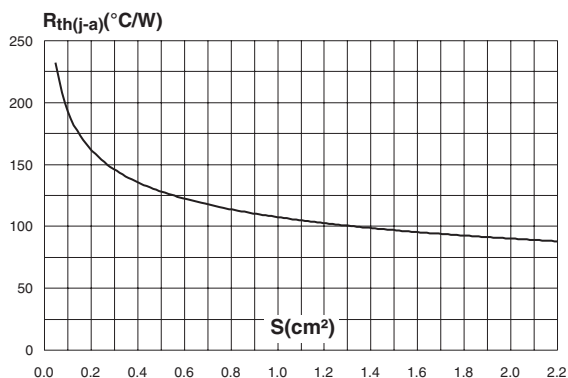

Figure 6: Reverse leakage current versus junction temperature (typical values)

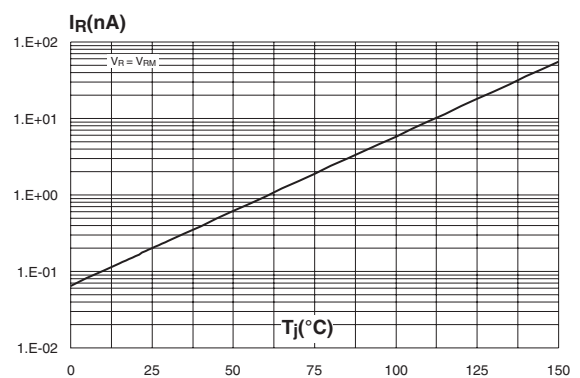

Figure 7: Clamping voltage versus peak pulse current (maximum values)

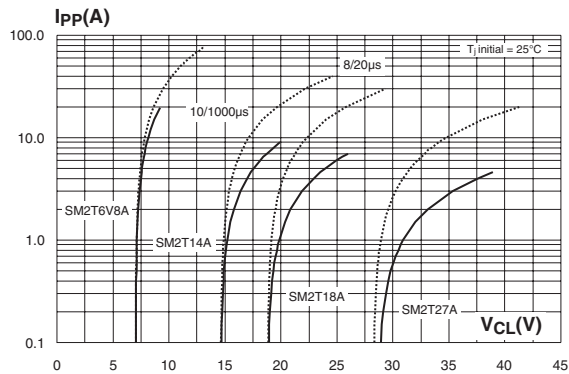

Figure 8: Junction capacitance versus reverse voltage applied (typical values)

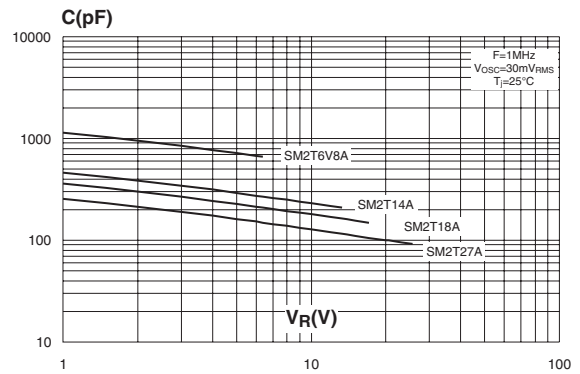

Fig. 9: Forward voltage drop versus forward current (typical values)

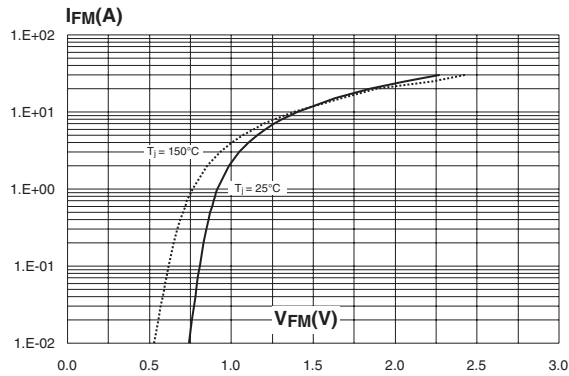

Figure 10: STmite Package Mechanical Data

Figure 11: STmite Foot Print Dimensions
(in millimeters)

Table 5: Ordering Information

Part Number	Marking	Package	Weight	Base qty	Delivery mode
SM2T6V8A	MUA	STmite	15.5 mg	12000	Tape & reel
SM2T14A	MUE				
SM2T18A	MUG				
SM2T27A	MUJ				

Table 6: Revision History

Date	Revision	Description of Changes
April-2002	1A	Last update.
Aug-2004	2	STmite package dimensions update.
14-Jan-2005	3	Minor layout update. No content change.

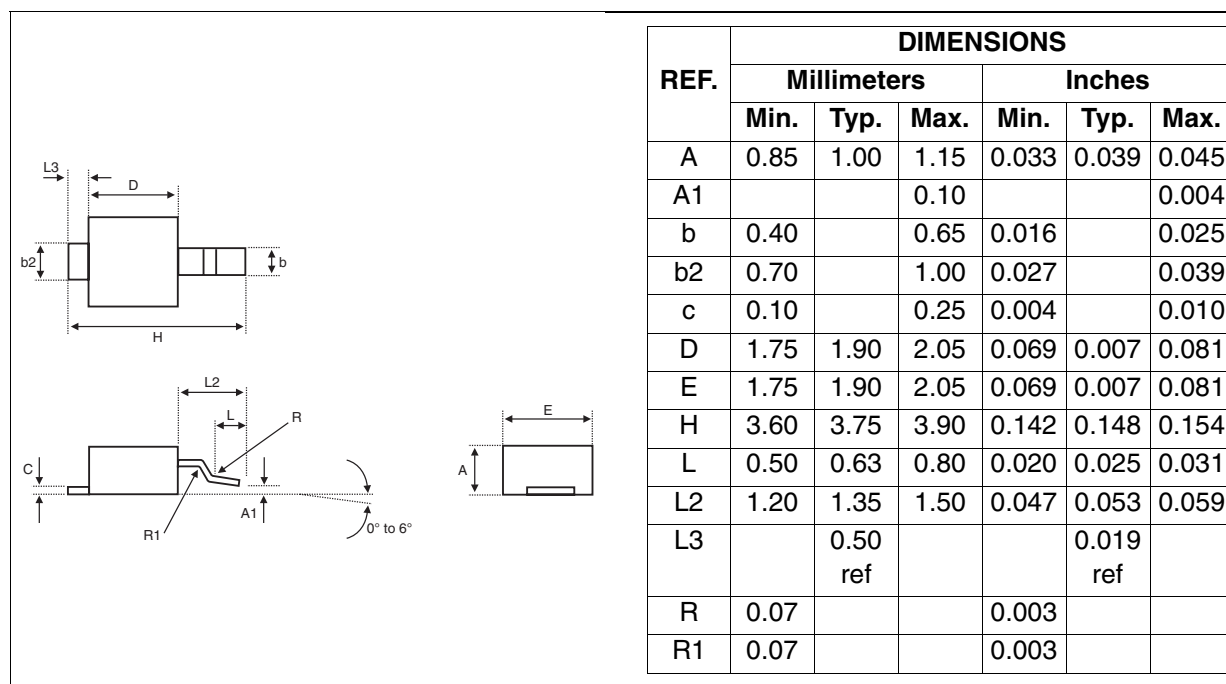
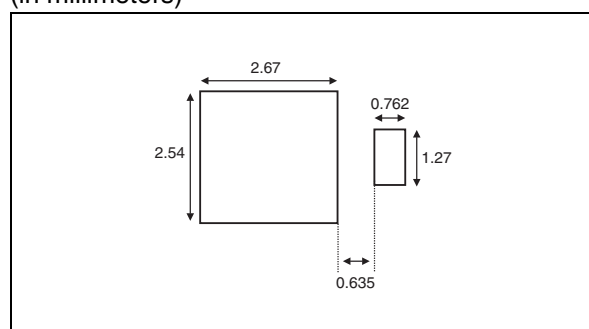
Information furnished is believed to be accurate and reliable. However, STMicroelectronics assumes no responsibility for the consequences of use of such information nor for any infringement of patents or other rights of third parties which may result from its use. No license is granted by implication or otherwise under any patent or patent rights of STMicroelectronics. Specifications mentioned in this publication are subject to change without notice. This publication supersedes and replaces all information previously supplied. STMicroelectronics products are not authorized for use as critical components in life support devices or systems without express written approval of STMicroelectronics.

The ST logo is a registered trademark of STMicroelectronics.
All other names are the property of their respective owners



© 2005 STMicroelectronics - All rights reserved

STMicroelectronics group of companies

Australia - Belgium - Brazil - Canada - China - Czech Republic - Finland - France - Germany - Hong Kong - India - Israel - Italy - Japan -
Malaysia - Malta - Morocco - Singapore - Spain - Sweden - Switzerland - United Kingdom - United States of America
www.st.com

Looking for pricing, stock, or lifecycle information?

Click below to explore more details on WIN SOURCE:

-  [View SM2T18A on WIN SOURCE](#)
-  [STMicroelectronics](#) Information

Optimize Your Supply Chain with WIN SOURCE Solutions

-  Global Sourcing Solution
-  Obsolete Management
-  Cost Control Management
-  Shortage Management
-  Alternative Solution
-  Excess Inventory Management