



THE DATASHEET OF B3F-1052



**Through-hole-mounting Switches
in a Wide Range of Models:
6 × 6 mm, 12 × 12 mm, Side-operated
Models, Gold-plated Contacts, and
Radial Tape**

- Extended mechanical/electrical durability: 10 x 10⁶ operations for 12 x 12 mm type and 1 x 10⁶ operations for the 6 x 6 mm type
- Taped radial type, vertical type and high force types are available.
- Gold plated models available for increased contact reliability, resistance to corrosive gas and insulation failure prevention for ion migration in harsh environments
- B32-series Key Tops mount to models with projected plungers.



RoHS Compliant

■ List of Models

6 × 6 mm Models

| Type | Contact material | Plunger | Height | Operating force (OF) | Plunger color | Bags | | | |
|---------------------------------|------------------|--|---|----------------------|-----------------|-------------------------|----------------------|----------------------|----------------------|
| | | | | | | Without ground terminal | Minimum packing unit | With ground terminal | Minimum packing unit |
| Standard: B3F-1000 Series | Silver plated | Flat type  | 4.3 mm | 0.98 N {100 gf} | Ivory | B3F-1000 | 100 pcs | B3F-1100 | 100 pcs |
| | | | | 1.47 N {150 gf} | Yellow | B3F-1002 | | B3F-1102 | |
| | | | | 2.55 N {260 gf} | Orange | B3F-1005 | | B3F-1105 | |
| | | | | 4.9 N {500 gf} | Red | B3F-1006 | | --- | |
| | | | 5.0 mm | 0.98 N {100 gf} | Black | B3F-1020 | | B3F-1120 | |
| | | | | 1.47 N {150 gf} | Gray | B3F-1022 | | B3F-1122 | |
| | | | | 2.55 N {260 gf} | Pink | B3F-1025 | | B3F-1125 | |
| | | | | 4.9 N {500 gf} | Blue | B3F-1026 | | --- | |
| | | | 5.0 mm (7.5-mm pitch) | 0.98 N {100 gf} | Black | --- | | B3F-1110 | |
| | | | 7.0 mm | 0.98 N {100 gf} | Black | B3F-1060 | | --- | |
| | | | | 1.47 N {150 gf} | Yellow | B3F-1062 | | --- | |
| | | | | 9.5 mm | 0.98 N {100 gf} | Black | | B3F-1070 | |
| | | 9.5 mm | 1.47 N {150 gf} | Yellow | B3F-1072 | --- | | | |
| | | | 2.55 N {260 gf} | Orange | B3F-1075 | --- | | | |
| | | | Projected type  | 7.3 mm | 0.98 N {100 gf} | Ivory | B3F-1050 | B3F-1150 | |
| | | 1.47 N {150 gf} | | Yellow | B3F-1052 | B3F-1152 | | | |
| | | 2.55 N {260 gf} | | Orange | B3F-1055 | B3F-1155 | | | |
| | | 4.9 N {500 gf} | | Red | B3F-1056 | --- | | | |

| Type | Contact material | Plunger | Height | Operating force (OF) | Plunger color | Bags | | | |
|--|------------------|---|---------|----------------------|---------------|-------------------------|----------------------|----------------------|----------------------|
| | | | | | | Without ground terminal | Minimum packing unit | With ground terminal | Minimum packing unit |
| Side-operated: B3F-3000 Series | Silver plated | Flat type  | 3.15 mm | 0.98 N {100 gf} | Ivory | --- | 100 pcs | B3F-3100 | 100 pcs |
| | | | | 1.47 N {150 gf} | Yellow | --- | | B3F-3102 | |
| | | | | 2.55 N {260 gf} | Orange | --- | | B3F-3105 | |
| | | | 3.85 mm | 0.98 N {100 gf} | Black | --- | | B3F-3120 | |
| | | | | 1.47 N {150 gf} | Gray | --- | | B3F-3122 | |
| | | | | 2.55 N {260 gf} | Pink | --- | | B3F-3125 | |
| | | Projected type  | 6.15 mm | 0.98 N {100 gf} | Ivory | --- | | B3F-3150 | |
| | | | | 1.47 N {150 gf} | Yellow | --- | | B3F-3152 | |
| | | | | 2.55 N {260 gf} | Orange | --- | | B3F-3155 | |
| High-reliability gold-plated: B3F-1000-G Series | Gold plated | Flat type  | 4.3 mm | 1.76 N {180 gf} | Yellow | B3F-1002-G | 100 pcs | B3F-1102-G | 100 pcs |
| | | | 5.0 mm | | Gray | B3F-1022-G | | B3F-1122-G | |
| | | | 7.0 mm | | Yellow | B3F-1062-G (see note) | | --- | |
| | | | 9.5 mm | | Yellow | B3F-1072-G (see note) | | --- | |
| | | Projected type  | 7.3 mm | | Yellow | B3F-1052-G | | --- | |
| Flat type  | 3.85 mm | | | Gray | --- | B3F-3122-G (see note) | | | |

Note: Bulk Packaged, 100 Switches per bag. Order in multiples of the package quantity.

12 × 12 mm Models

| Type | Contact material | Plunger (or LED color) | Height | Operating force (OF) | Plunger color | Bags | | | |
|--|------------------|------------------------|--------|----------------------|---------------|-------------------------|----------------------|----------------------|----------------------|
| | | | | | | Without ground terminal | Minimum packing unit | With ground terminal | Minimum packing unit |
| Standard: B3F-4000 Series | Silver plated | Flat type | 4.3 mm | 1.27 N {130 gf} | Ivory | B3F-4000 | 100 pcs | B3F-4100 | 100 pcs |
| | | | | 2.55 N {260 gf} | Yellow | B3F-4005 | | B3F-4105 | |
| | | Projected type | 7.3 mm | 1.27 N {130 gf} | Ivory | B3F-4050 | | B3F-4150 | |
| | | | | 2.55 N {260 gf} | Yellow | B3F-4055 | | B3F-4155 | |
| Long durability: B3F-5000 Series | Silver plated | Flat type | 4.3 mm | 1.27 N {130 gf} | Blue | B3F-5000 | 100 pcs | B3F-5100 | 100 pcs |
| | | Projected type | 7.3 mm | | Blue | B3F-5050 | | B3F-5150 | |
| High reliability gold-plated: B3F-5001 Series | Gold plated | Flat type | 4.3 mm | 1.27 N {130 gf} | Blue | B3F-5001 | 100 pcs | B3F-5101 | 100 pcs |
| | | Projected type | 7.3 mm | | Blue | B3F-5051 | | B3F-5151 | |

Note: Bulk Packaged, 100 switches per bag. Order in multiples of the package quantity.

6 × 6 mm Radial Models (Taping Specifications)

| Type | Contact material | Plunger | Height | Operating force (OF) | Plunger color | Taped Radial | | | |
|----------------------------------|------------------|----------------|--------|----------------------|---------------|-------------------------|----------------------|----------------------|----------------------|
| | | | | | | Without ground terminal | Minimum packing unit | With ground terminal | Minimum packing unit |
| Taped Radial: B3F-6000 Series | Silver plated | Flat type | 4.3 mm | 0.98 N {100 gf} | Ivory | B3F-6000 | 1,000 pcs | B3F-6100 | 1,000 pcs |
| | | | | 1.47 N {150 gf} | Yellow | B3F-6002 | | B3F-6102 | |
| | | | 5.0 mm | 0.98 N {100 gf} | Black | B3F-6020 | | B3F-6120 | |
| | | | | 1.47 N {150 gf} | Gray | B3F-6022 | | B3F-6122 | |
| | | Projected type | 7.3 mm | 0.98 N {100 gf} | Ivory | B3F-6050 | | B3F-6150 | |
| | | | | 1.47 N {150 gf} | Yellow | B3F-6052 | | B3F-6152 | |

Note: The switches are tape packaged in units of 1,000 per package. Order in multiples of the package size. Switches are not sold individually.

■ Ratings/Characteristics

| | |
|---|--|
| Rating (resistive load) | 1 to 50 mA, 3 to 24 VDC (B3F-G: 100 μ A to 50 mA, 3 to 24 VDC) |
| Minimum applicable load (reference value) | 10 μ A at 1 VDC (resistive load) |
| Ambient operating temperature | -25°C to +70°C at 60%RH max. (with no icing or condensation) |
| Ambient operating humidity | 35% to 85% (at +5 to +35°C) |
| Contact form | SPST-NO |
| Contact resistance (initial value) | 100 m Ω max. |
| Insulation resistance | 100 M Ω min. (at 250 VDC with insulation tester) |
| Dielectric strength | 500 VAC, 50/60 Hz for 1 min |
| Bounce time | 5 ms max. |
| Vibration resistance | Malfunction: 10 to 55 Hz, 1.5 mm double amplitude |
| Shock resistance | Destruction: 1,000 m/s ² {approx. 100G} max. Malfunction: 100 m/s ² {approx. 10G} max. |
| Durability | B3F-1000, B3F-3000, B3F-6000: 1,000,000 operations min (OF: 0.98 N {100 gf}) (B3F-1070: 500,000 operations min) 300,000 operations min (OF: 1.47 N {150 gf}) 100,000 operations min (OF: 2.55 N {260 gf}) 50,000 operations min (OF: 4.9 N {500 gf}) B3F-4000: 3,000,000 operations min (OF: 1.27 N {130 gf}) 1,000,000 operations min (OF: 2.55 N {260 gf}) B3F-5000/5001: 10,000,000 operations min. B3F-G: 300,000 operations min. |
| Weight | 6 \times 6 mm models: approx. 0.25 g 12 \times 12 mm models (standard types): approx. 0.85 g Radial models: approx. 0.25 g |
| Degree of protection | IEC IP00 |
| Washing | Not possible |

■ Operating Characteristics

6 \times 6 mm Models

| Operating force (OF) | B3F-1000, B3F-3000, B3F-6000 | | | | B3F-G |
|----------------------|---|--|--|--|---|
| | 0.98 N | 1.47 N | 2.55 N | 4.9 N | 1.76 N |
| Item | B3F-1□□0 B3F-3□□0 B3F-6□□0 | B3F-1□□2 B3F-3□□2 B3F-6□□2 | B3F-1□□5 B3F-3□□5 | B3F-10□6 | B3F-1□□2-G B3F-3□□2-G |
| Operating force (OF) | 0.98 \pm 0.29 N {100 \pm 30 gf} | 1.47 \pm 0.49 N {150 \pm 50 gf} | 2.55 \pm 0.69 N {260 \pm 70 gf} | 4.9 \pm 1.47 N {500 \pm 150 gf} | 1.76 \pm 0.49 N {180 \pm 50 gf} |
| Releasing force (RF) | 0.2 N {20 gf} min. | 0.49 N {50 gf}min. | 0.49 N {50 gf}min. | 0.7 N {70 gf} min. | 0.49 N {50 gf}min. |
| Pretravel (PT) | 0.25 ^{+0.2} / _{-0.1} mm | | | | 0.25 ^{+0.2} / _{-0.1} mm |

12 \times 12 mm Models

| Operating force (OF) | B3F-4000, B3F-5000, B3F-5001 | |
|----------------------|--|--|
| | 1.27 N | 2.55 N |
| Item | B3F-4□□0 B3F-5□□0 B3F-5□□1 | B3F-4□□5 |
| Operating force (OF) | 1.27 \pm 0.49 N {130 \pm 50 gf} | 2.55 \pm 0.69 N {260 \pm 70 gf} |
| Releasing force (RF) | 0.29 N {30 gf} min. | 0.49 N {50 gf} min. |
| Pretravel (PT) | 0.3 ^{+0.2} / _{-0.1} mm | |

■ Dimensions (Unit: mm)

Note: The numbers used for terminals in the following graphics are indicated in the "Bottom View" diagram below. In this diagram, the Switch is rotated so that the terminals are on the right and left-hand sides, and the OMRON logo appears the right way up. (Except Side-operated and Radial Models)



6 × 6 mm Models

Standard, Flat Plunger Type (without Ground Terminal)

B3F-1000, B3F-1002, B3F-1005, B3F-1006
 B3F-1020 (See note.), B3F-1022 (See note.),
 B3F-1025 (See note.), B3F-1026 (See note.)
 B3F-1002-G, B3F-1022-G (See note.)



Note: The height of B3F-1020, B3F-1022, B3F-1025, and B3F-1026 is 5±0.2 mm.

Standard, Flat Plunger Type (with Ground Terminal)

B3F-1100, B3F-1102, B3F-1105
 B3F-1120 (See note.), B3F-1122 (See note.)
 B3F-1125 (See note.)
 B3F-1102-G, B3F-1122-G (See note.)



Note: The height of B3F-1120, B3F-1122, and B3F-1125 is 5±0.2 mm.

Standard, Flat Plunger Type (with Ground Terminal, Pitch: 7.5 mm)

B3F-1110

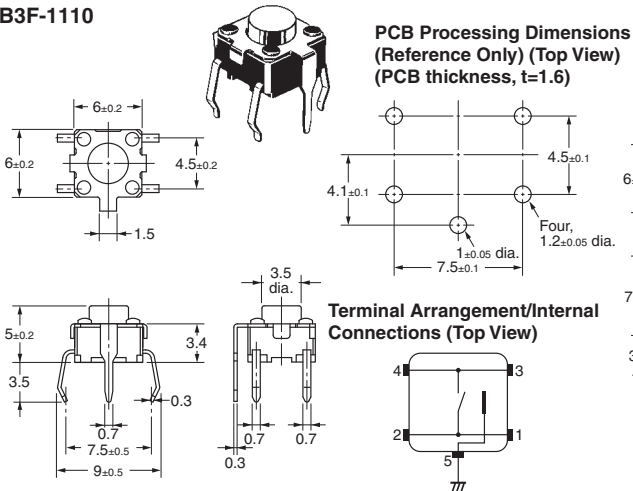

Standard, Flat Plunger Type (without Ground Terminal)

B3F-1060, B3F-1062, B3F-1062-G

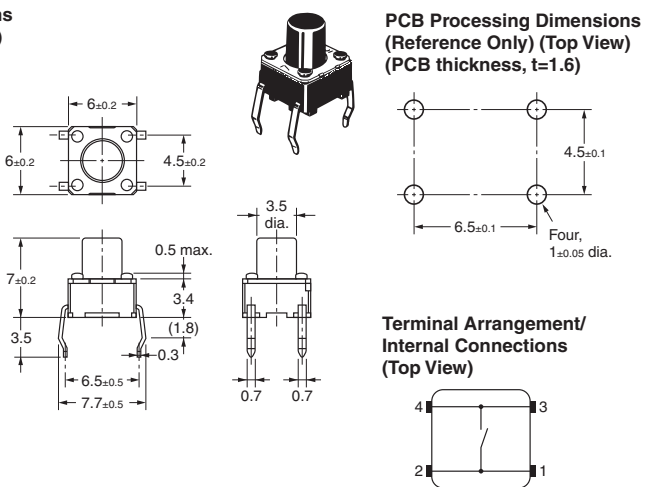

Note: Unless otherwise specified, a tolerance of ±0.4 mm applies to all dimensions. No terminal numbers are indicated on the Switches.

**Standard, Flat Plunger Type
(without Ground Terminal)**

B3F-1070, B3F-1072, B3F-1075, B3F-1072-G



**Standard, Projected Plunger Type
(without Ground Terminal)**

**B3F-1050, B3F-1052
B3F-1055, B3F-1056
B3F-1052-G**



**Standard, Projected Plunger Type
(with Ground Terminal)**

B3F-1150, B3F-1152, B3F-1155



Side-operated, Flat Plunger Type

B3F-3100, B3F-3102, B3F-3105

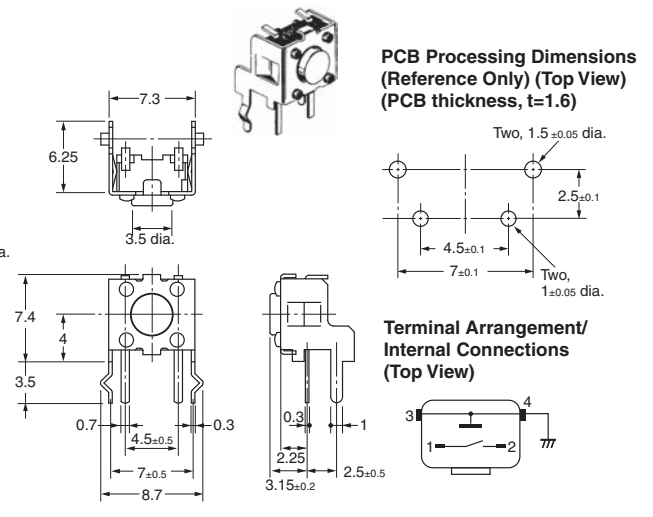

Side-operated, Flat Plunger Type (Height: 3.85 mm)

B3F-3120, B3F-3122, B3F-3125, B3F-3122-G



Side-operated, Projected Plunger Type

B3F-3150, B3F-3152, B3F-3155



Note: Unless otherwise specified, a tolerance of ±0.4 mm applies to all dimensions. No terminal numbers are indicated on the Switches.

12 × 12 mm Models

Standard, Long-durability, and High-reliability Models Flat Plunger Type (without Ground Terminal)

B3F-4000, B3F-4005, B3F-5000, B3F-5001



PCB Processing Dimensions (Reference Only) (Top View) (PCB thickness, t=1.6)



Terminal Arrangement/Internal Connections (Top View)



Standard, Long-durability, and High-reliability Models Flat Plunger Type (with Ground Terminal)

B3F-4100, B3F-4105, B3F-5100, B3F-5101



PCB Processing Dimensions (Reference Only) (Top View) (PCB thickness, t=1.6)

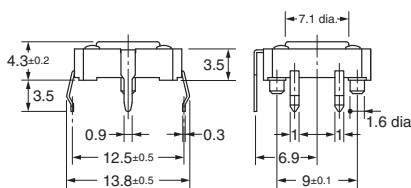

Terminal Arrangement/Internal Connections (Top View)

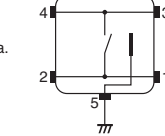

Standard, Long-durability, and High-reliability Models Projected Plunger Type (without Ground Terminal)

B3F-4050, B3F-4055, B3F-5050, B3F-5051

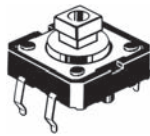

PCB Processing Dimensions (Reference Only) (Top View) (PCB thickness, t=1.6)

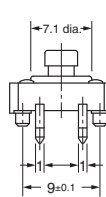
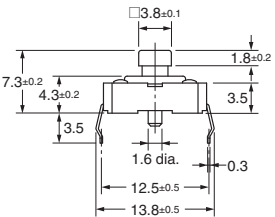
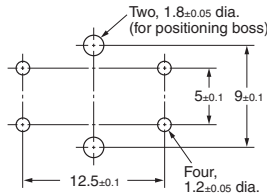
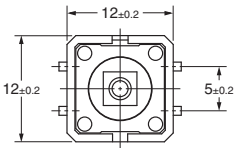

Terminal Arrangement/Internal Connections (Top View)

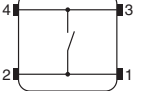

Standard, Long-durability, and High-reliability Models Projected Plunger Type (with Ground Terminal)

B3F-4150, B3F-4155, B3F-5150, B3F-5151

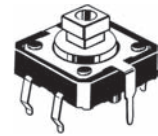

PCB Processing Dimensions (Reference Only) (Top View) (PCB thickness, t=1.6)

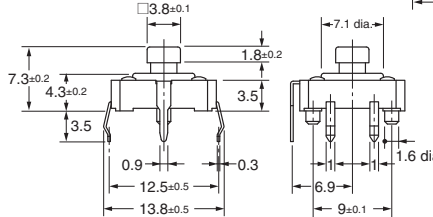
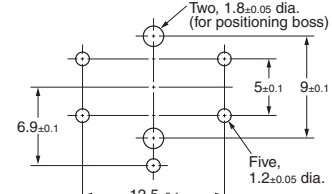
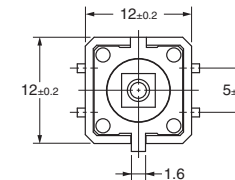

Terminal Arrangement/Internal Connections (Top View)

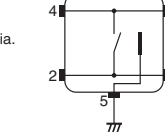

Note: Unless otherwise specified, a tolerance of ±0.4 mm applies to all dimensions.

Note: The numbers used for terminals in the following graphics are indicated in the "Bottom View" diagram below. In this diagram, the Switch is rotated so that the terminals are on the right and left-hand sides, and the OMRON logo appears the right way up.



6 mm × 6 mm Radial Types (Taping Specifications): Sold in Units of 1,000 Switches

**Flat Plunger Type
(without Ground Terminal)
B3F-6000, B3F-6002**



**PCB Processing Dimensions
(Reference Only) (Top View)
(PCB thickness, t=1.6)**

**Terminal Arrangement
/Internal Connections
(Top View)**

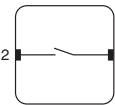
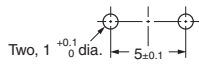

Note: The tape is random between surface A and surface B.

**Flat Plunger Type
(with Ground Terminal)
B3F-6100, B3F-6102**

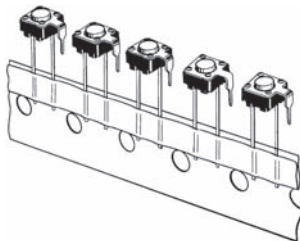

**PCB Processing Dimensions
(Reference Only) (Top View)
(PCB thickness, t=1.6)**

**Terminal Arrangement
/Internal Connections
(Top View)**



**Flat Plunger Type
(without Ground Terminal)
B3F-6020, B3F-6022**

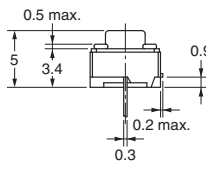
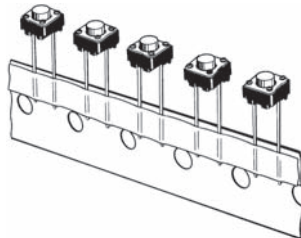

**PCB Processing Dimensions
(Reference Only) (Top View)
(PCB thickness, t=1.6)**

**Terminal Arrangement
/Internal Connections
(Top View)**

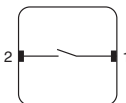

Note: The tape is random between surface A and surface B.

Note: Unless otherwise specified, a tolerance of ±0.4 mm applies to all dimensions. No terminal numbers are indicated on the Switches.

■ Key Tops

B32-series Key Tops are available for projected plungers. Refer to the Datasheet of B32 for details.

■ Precautions

Be sure to read the safety precautions common to all Tactile Switches for correct use.

- Application examples provided in this document are for reference only. In actual applications, confirm equipment functions and safety before using the product.
- Consult your OMRON representative before using the product under conditions which are not described in the manual or applying the product to nuclear control systems, railroad systems, aviation systems, vehicles, combustion systems, medical equipment, amusement machines, safety equipment, and other systems or equipment that may have a serious influence on lives and property if used improperly. Make sure that the ratings and performance characteristics of the product provide a margin of safety for the system or equipment, and be sure to provide the system or equipment with double safety mechanisms.

Note: Do not use this document to operate the Unit.



OMRON Corporation
Electronic and Mechanical Components Company

Contact: www.omron.com/ecb

Cat. No. A070-E1-08
1014(0207)(O)

Looking for pricing, stock, or lifecycle information?

Click below to explore more details on WIN SOURCE:

-  [View B3F-1052 on WIN SOURCE](#)
-  [Omron Information](#)

Optimize Your Supply Chain with WIN SOURCE Solutions

-  Global Sourcing Solution
-  Obsolete Management
-  Cost Control Management
-  Shortage Management
-  Alternative Solution
-  Excess Inventory Management